

Rotec SMC Stub Flange

Drilling Standard: EN1092 PN16

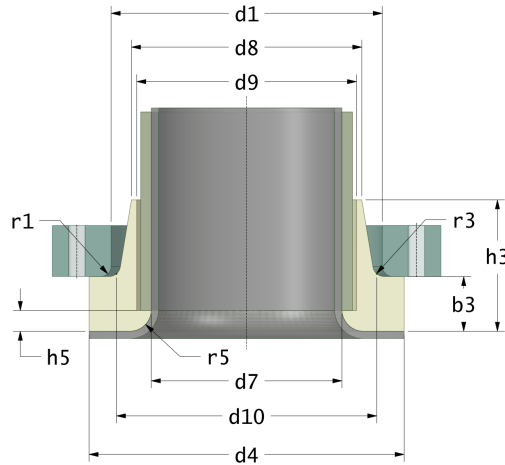
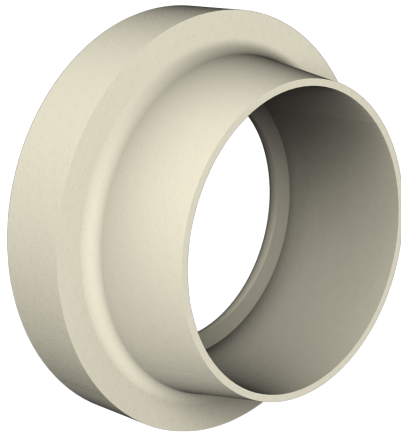

#	DN (mm)	Pmax (bar)	d4 (mm)	d7 (mm)	d9 (mm)	d8 (mm)	d1 (mm)	d10 (mm)	r1 (mm)	r3 (mm)	h5 (mm)	r5 (mm)	h3 (mm)	b3 (mm)	Article Number
1	25	16	68	32	37	45	51	50	3	2	4	3	30	12	SFP-25-32-68-16
2	32	16	78	40	46	53	59	58	3	3	4	3	32	14	SFP-32-40-78-16
3	40	16	88	50	55	64	69	68	3	3	4	3	38	17	SFP-40-50-88-16
4	50	16	102	63	69	78	83	82	3	3	6	4	44	18	SFP-50-63-102-16
5	65	16	122	75	80	90	96	95	4	3	6	4	48	15	SFP-65-75-122-16
6	80	10	138	90	95	105	112	111	4	3	6	4	53	17	SFP-80-90-138-10
7	80	16	138	90	95	105	112	111	4	3	6	4	59	23	SFP-80-90-138-16
8	100	10	158	110	115	127	134	133	5	4	8	4	55	18	SFP-100-110-158-10
9	100	16	158	110	115	127	134	133	5	4	8	4	62	25	SFP-100-110-158-16
10	125	10	188	125	133	142	161	160	5	4	8	4	64	20	SFP-125-125-188-10
11	125	10	188	125	130	142	161	160	5	4	8	4	64	20	SFP-125-126-188-10
12	150	10	212	160	165	180	189	188	5	4	8	4	71	22	SFP-150-160-212-10
13	150	16	212	160	165	180	189	188	5	4	8	4	81	32	SFP-150-160-212-16
14	200	6	268	200	205	220	238	237	6	5	8	4	85	25	SFP-200-201-268-06
15	200	10	268	200	205	220	238	237	6	5	8	4	94	34	SFP-200-201-268-10
16	250	6	320	250	255	270	294	293	6	5	8	4	101	28	SFP-250-251-320-06
17	300	6	376	300	305	323	344	343	6	5	8	4	117	30	SFP-300-301-376-06
18	300	10	376	300	305	323	344	343	6	5	8	4	127	40	SFP-300-301-376-10

Disclaimer

Whilst every care is taken to ensure that the information on this website is complete and accurate, AdComp Processing Technology Pvt. Ltd. India cannot accept responsibility for any omissions or inaccuracies or for any consequences arising therefrom. By using this website, the user accepts the terms of this disclaimer.

07-02-2023